



P R E S E N T A T I O N

VNS FAB WORKS

COMPANY PROFILE



WELCOME TO OUR COMPANY

LEARN

MORE

VNS Fab Works is a leading provider of high-quality uPVC doors and windows, catering to a wide range of customers in the construction industry. With a prime focus on delivering innovative, energy-efficient, and aesthetically appealing products, VNS Fab Works has established itself as a reliable and trustworthy brand in the market. This essay aims to provide an in-depth analysis of VNS Fab Works, its product offerings, and its commitment to customer satisfaction and sustainability.

These products are carefully designed to meet the needs of various residential, commercial, and industrial projects. The company's uPVC doors and windows are renowned for their durability, strength, and modern aesthetics. On the other hand, uPVC doors and windows are known for their excellent thermal insulation properties, making them energy-efficient and cost-effective in the long run.



P R E S E N T A T I O N

VISION & MISSION



Vision

Looking into the future we hope to occupy the minds of the customers by being the most preferred High-End Aluminium & uPVC Manufacturer and Supplier with offerings such as customized solutions, discernment, practical knowledge, product prowess and integrity.

Mission

Guided by the relentless focus of our visions and values, we deliver top of the line products and tailored solutions through continuous innovations within the domain of High-End Aluminium & uPVC technology and immense product knowledge for sustained profitability.

P R E S E N T A T I O N

WHAT DO YOU KNOW ABOUT OUR COMPANY?

Philosophy

At VNS Fab Works, our philosophy is to constantly, continually improve and innovate. We keep a positive impact on the communities we touch providing superior, efficient products and services which meet the ever-changing needs for both our current and prospective clients, while continuing to strive for the highest professional excellence in the delivery of those products and services.

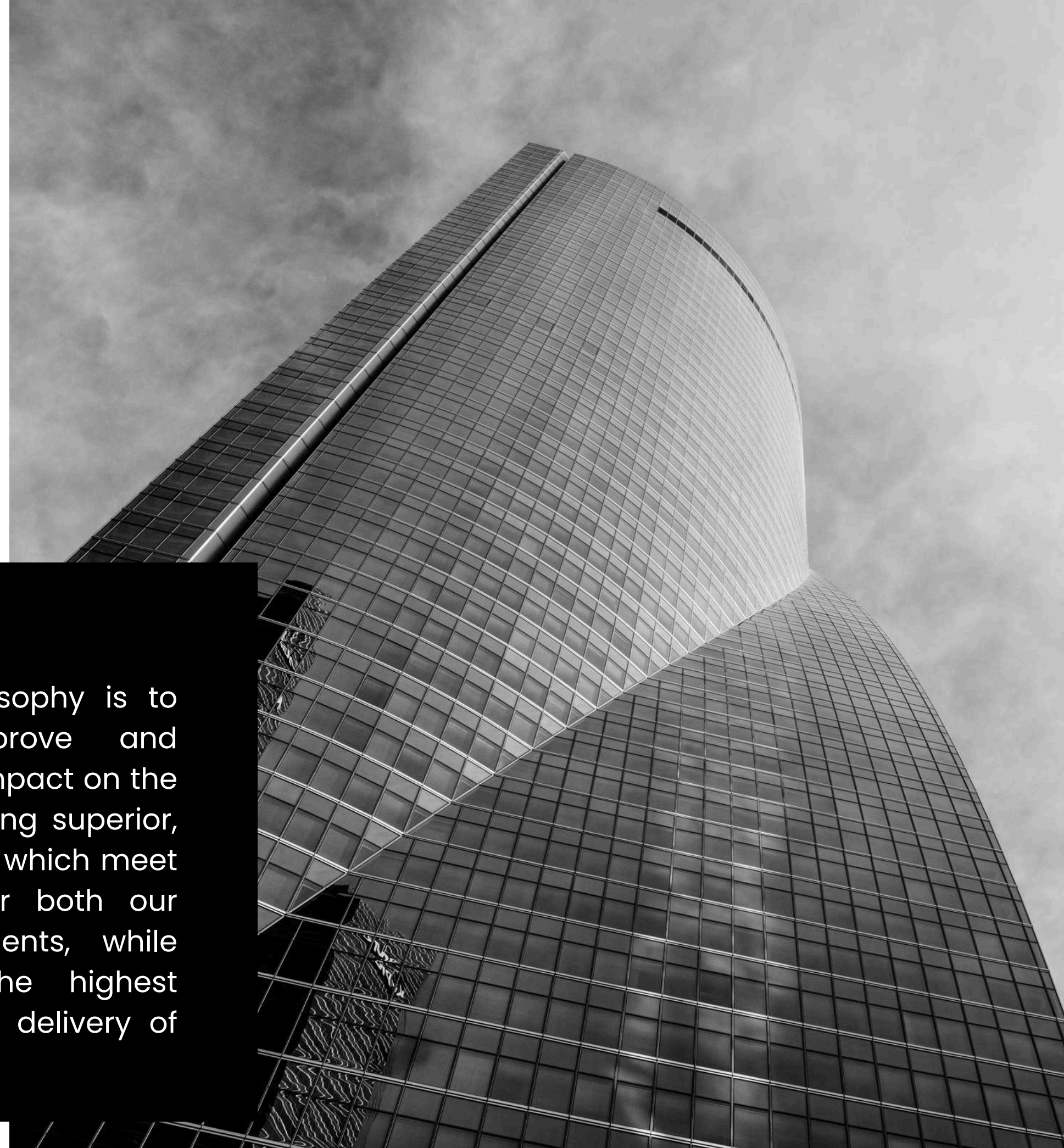

OUR CURRENT PROJECT IN 2025

01

CHC District Hospital, Pichhor Shivpuri MP

02

CHC Luvkush Nagar, MP

03

CM Rise School, Barigarh Chatarpur MP

04

Namo Homes Society Club House, Jhansi UP

05

Kasturi Club Resort, Datia Madhya Pradesh



PROJECTS COMPLETED IN 2024-25

01

District Tehsil, Bhandar Madhya Pradesh.

02

CHC Hospital, Nogaon Madhya Pradesh

03

Boys Hostel, RLBCAU Agriculture University, Jhansi
Uttar Pradesh

04

SM Tower, ITI Collage, Jhansi Uttar Pradesh

05

District Hospital, Chatarpur, Madhya Pradesh

06

Maharaja Chhatrasal University, Bagaita,
Chatarpur, Madhya Pradesh

07

Boys Hostel and 2 more blocks, RLBCAU
Agriculture University, Jhansi Uttar Pradesh



SPECIAL SERVICE

Platinum Service

VNS Fab Works Pvt. Ltd. takes pride in its team of highly skilled professionals who possess extensive knowledge and expertise in the field. The company invests in regular training and development programs to ensure that its staff stays updated with the latest trends, technologies, and regulations. This enables VNS to continuously improve its products and maintain its position as an industry leader.

Furthermore, VNS Fab Works is committed to maintaining strong relationships with its customers, suppliers, and industry partners. The company values open communication, transparency, and ethical business practices, which are integral to its success. By fostering long-term partnerships, VNS Fab Works aims to build trust and loyalty, ensuring continued growth and mutual success.



PRODUCTION FACILITY
NCL VEKA, HYDERABAD

PERFECT FOR DECADES



Lead – Free

Our team at NCL VEKA has committed to work towards a greener environment, using Lead-Free stabilizer is a step in this movement



Weatherability

Usage of Co- Extruded beads make sure that the windows have the same performance in spite of any harsh weather conditions



Energy-Efficient

With U-value as low as 0.4 and multi-chambered structures , VEKA windows prevents transfer of heat inside your house.



Long Lasting Strength

Most uPVC tends to change its colour and property due to sustained exposure to UV radiation. The engineered blend used in VEKA windows us UV stabilized that gives it a long life



Healthier Indoor Air

High Quality Wool Pile and double layer sealing ensure that dust and pollution are barred from your home



Safe & Secure

With a concealed reinforcement to withstand high wind-pressure and fluctuating loads, making them safe and secure

TESTING & CERTIFICATIONS FOR uPVC PROFILE

We use **Lead free stabilizers** in the extrusion of uPVC profiles and are certified by **SGS** .

Our Profiles are regularly tested for physical , chemical properties at **CIPET** (Central Institute of Plastic Engineering & Technology)



TEST REPORT

Report No. : **MAN:HL:7480009027** DATE : **12th October, 2016**

NCL WINTECH INDIA LIMITED
 63,569 ROCK DALE COMPOUND, SOMAJIGUDA
 HYDERABAD-500082
 INDIA
 CONTACT PERSON : MR. P.P. PRABHAKARAN

THE FOLLOWING SAMPLE(S) WAS/WERE SUBMITTED AND IDENTIFIED BY ON BEHALF OF THE CUSTOMER AS :

SAMPLE DESCRIPTION	WINTECH UPVC COMPOUND
COLOUR	WHITE
ORDER NUMBER	NCL/WIN/001, DT- 27.09.16
COUNTRY OF ORIGIN	INDIA
SAMPLE RECD ON	30/09/2016
TEST PERFORMING DATE	05/10/2016 TO 12/10/2016

TEST REQUESTED : Selected test (s) as requested by client.

TEST METHOD : Please refer to next page(s).

TEST RESULTS: : Please refer to next page(s).

CONCLUSION : Based on the performed tests on selected part of submitted samples, the results of Lead, Mercury, Cadmium, Hexavalent chromium, Polybrominated biphenyls (PBB), Polybrominated diphenyl ethers (PBDE), Bis(2-ethylhexyl) phthalate (DEHP), Butyl benzyl phthalate (BBP), Dibutyl phthalate (DBP), and Diisobutyl phthalate (DIBP) & Hexabromocyclododecane (HBCDD) comply with the limits as set by Directive (EU) 2015/863 amending Annex II to Directive 2011/65/EU.

Per Pro SGS India Pvt Ltd.



Subasini Saraswat
 Asst. Manager
 Email your Test Report Related Enquiries at Feedback.HLT@sgs.com



VEKA – ADVANTAGES

Usage of **German Technology** to suit Indian Tropical Climatic conditions

Flexible **Design options** – Arch window, bay windows, etc

End-to-End Solution – right from design suggestion to installation

Unmatched Service Quality – available all over the country

Largest Fabricator Network – 120 Fabricators in India



Insulation in VEKA Windows:

- Gaskets made of TPE, this allows the gaskets to be welded along with profile
- Double layer of sealing ensures dust and pollutants stay outside

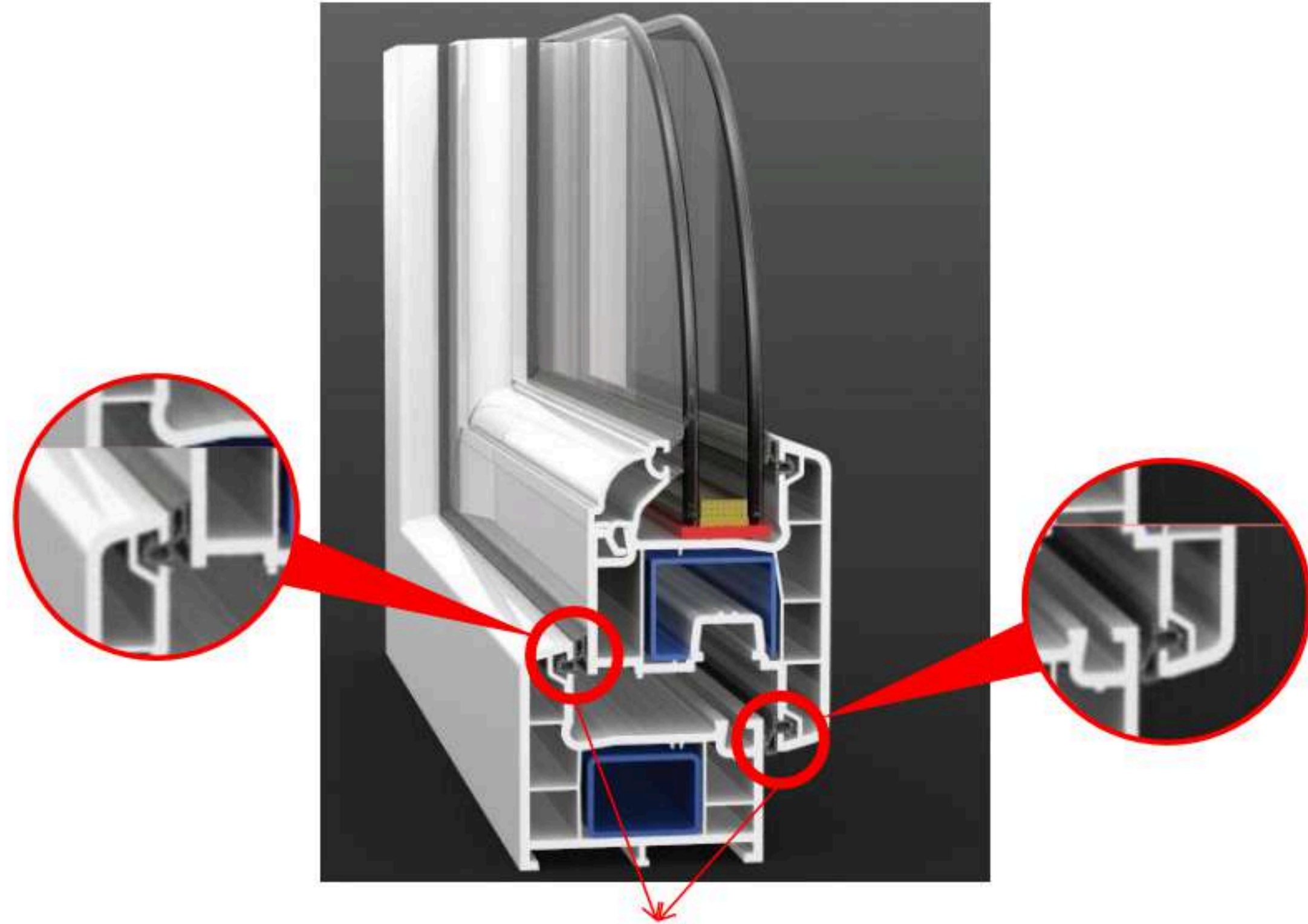

Double layer of sealing

Window Design

- Fixed windows
- Casement Windows
- Casement with Security Grill
- Top Hung
- Tilt & Turn
- Arched Window
- Combination Window
- Bay Window
- Sliding Windows
- Fold & Slide
- Lift & Slide
- Invisi Fold System



Sliding Series

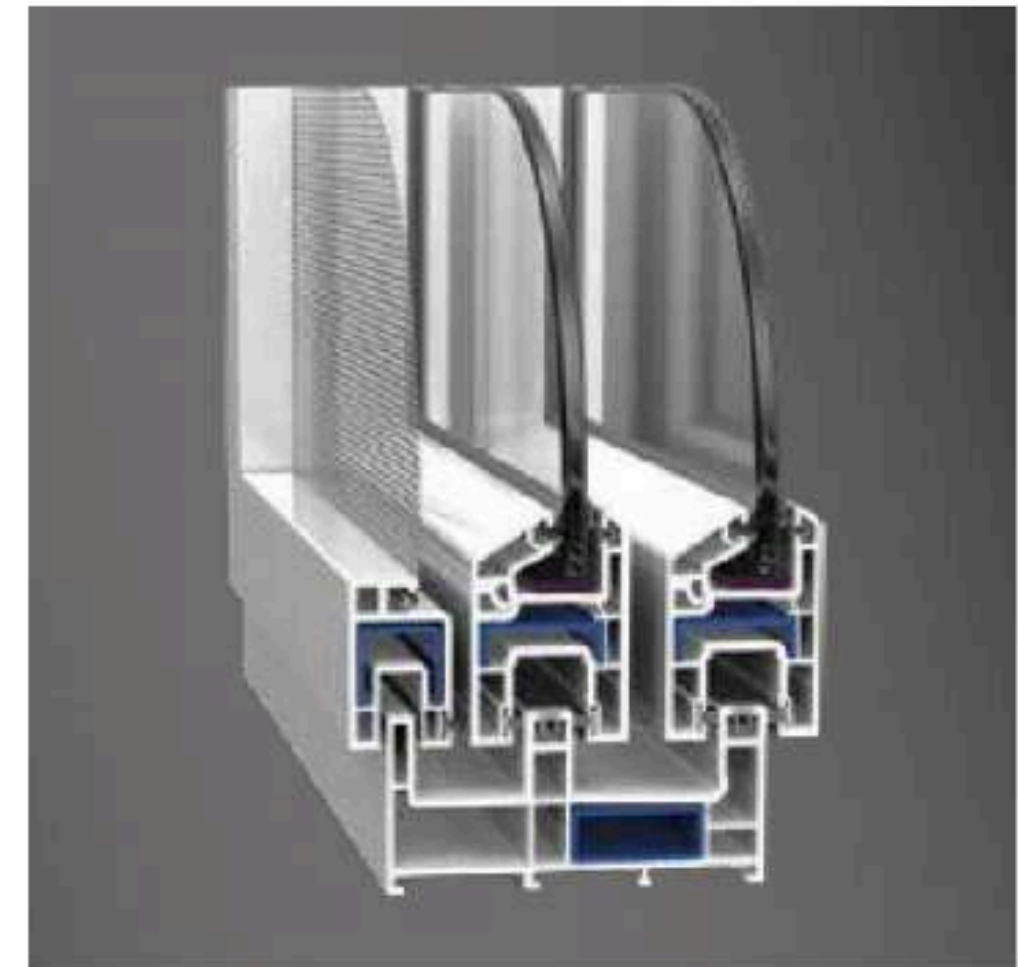
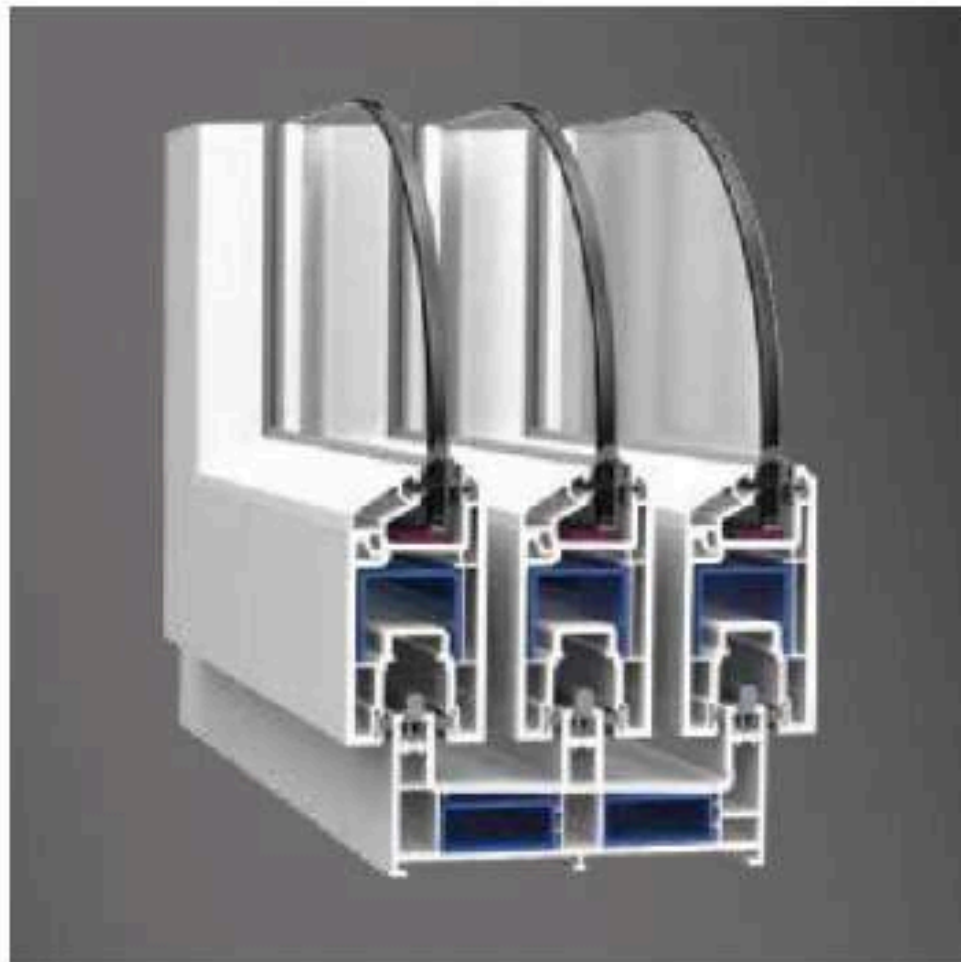
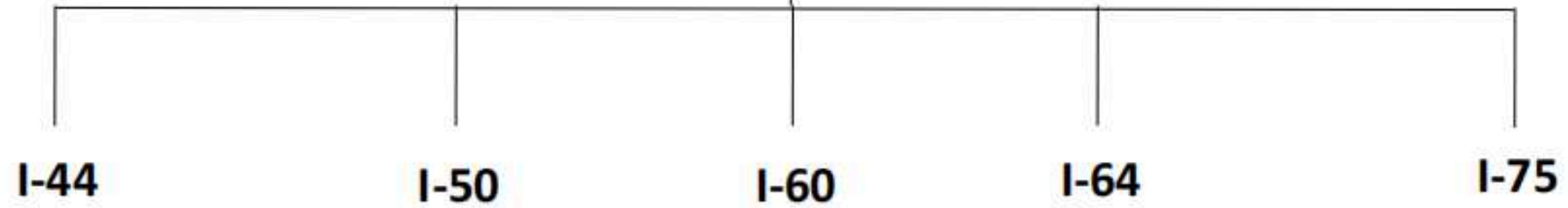

Casement Series

I-39



I-60

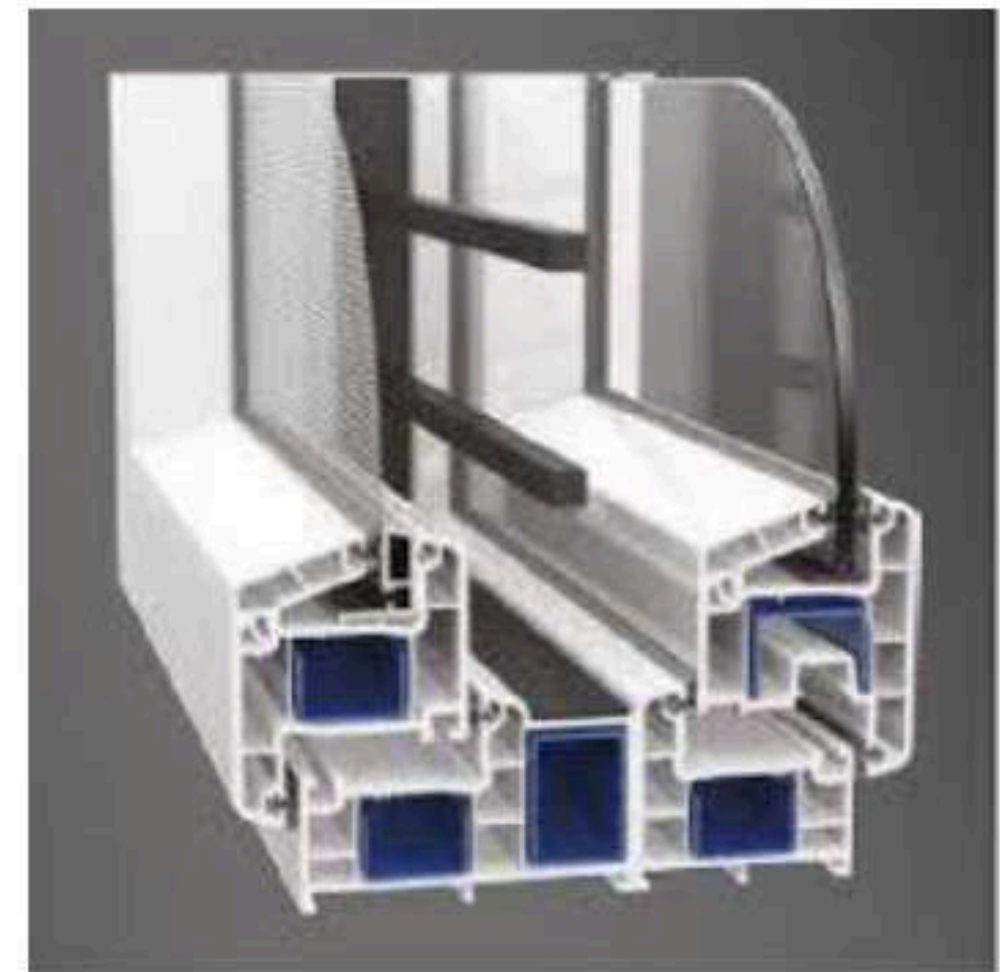

Site Pics



Site Pics



CONTACT US

**We look forward to working
with you**

 **Phone : +91-7897412424/9935647619/9450636074**

 **Website : www.vnsfabworks.com**

 **Email : vnsfabworks@gmail.com**

 **Address : D-28 Bijauli Industrial Area, Jhansi
U.P. 284002**



THANK YOU

